

2N5401

Preferred Device

Amplifier Transistors PNP Silicon

Features

- Pb-Free Packages are Available*

MAXIMUM RATINGS

| Rating | Symbol | 2N5400 | 2N5401 | Unit |
|---|----------------|-------------|--------|-------------------------------|
| Collector – Emitter Voltage | V_{CEO} | 120 | 150 | Vdc |
| Collector – Base Voltage | V_{CBO} | 130 | 160 | Vdc |
| Emitter – Base Voltage | V_{EBO} | 5.0 | | Vdc |
| Collector Current – Continuous | I_C | 600 | | mAdc |
| Total Device Dissipation @ $T_A = 25^\circ\text{C}$ Derate above 25°C | P_D | 625 5.0 | | mW mW/ $^\circ\text{C}$ |
| Total Device Dissipation @ $T_C = 25^\circ\text{C}$ Derate above 25°C | P_D | 1.5 12 | | Watts mW/ $^\circ\text{C}$ |
| Operating and Storage Junction Temperature Range | T_J, T_{stg} | –55 to +150 | | $^\circ\text{C}$ |

Maximum ratings are those values beyond which device damage can occur. Maximum ratings applied to the device are individual stress limit values (not normal operating conditions) and are not valid simultaneously. If these limits are exceeded, device functional operation is not implied, damage may occur and reliability may be affected.

THERMAL CHARACTERISTICS

| Characteristic | Symbol | Max | Unit |
|--|-----------------|------|---------------------------|
| Thermal Resistance, Junction-to-Ambient | $R_{\theta JA}$ | 200 | $^\circ\text{C}/\text{W}$ |
| Thermal Resistance, Junction-to-Case | $R_{\theta JC}$ | 83.3 | $^\circ\text{C}/\text{W}$ |



ON Semiconductor®

<http://onsemi.com>

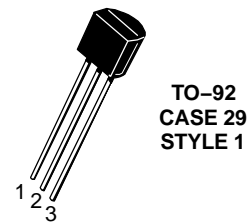
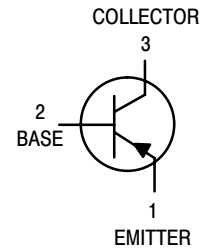

MARKING DIAGRAM

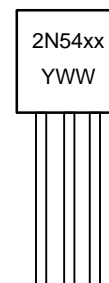

Y = Year
WW = Work Week

ORDERING INFORMATION

See detailed ordering and shipping information in the package dimensions section on page 2 of this data sheet.

*For additional information on our Pb-Free strategy and soldering details, please download the ON Semiconductor Soldering and Mounting Techniques Reference Manual, SOLDERRM/D.

Preferred devices are recommended choices for future use and best overall value.

2N5401

ELECTRICAL CHARACTERISTICS ($T_A = 25^\circ\text{C}$ unless otherwise noted)

| Characteristic | Symbol | Min | Max | Unit |
|--|------------------|--------|----------|------|
| OFF CHARACTERISTICS | | | | |
| Collector–Emitter Breakdown Voltage ⁽¹⁾ ($I_C = 1.0\text{ mAdc}$, $I_B = 0$) | $V_{(BR)CEO}$ | 150 | – | Vdc |
| | 2N5400 2N5401 | | | |
| Collector–Base Breakdown Voltage ($I_C = 100\ \mu\text{Adc}$, $I_E = 0$) | $V_{(BR)CBO}$ | 160 | – | Vdc |
| | 2N5400 2N5401 | | | |
| Emitter–Base Breakdown Voltage ($I_E = 10\ \mu\text{Adc}$, $I_C = 0$) | $V_{(BR)EBO}$ | 5.0 | – | Vdc |
| Collector Cutoff Current ($V_{CB} = 120\text{ Vdc}$, $I_E = 0$) ($V_{CB} = 120\text{ Vdc}$, $I_E = 0$, $T_A = 100^\circ\text{C}$) | I_{CBO} | – – | 50 50 | |
| | 2N5401 2N5401 | | | |
| Emitter Cutoff Current ($V_{EB} = 3.0\text{ Vdc}$, $I_C = 0$) | I_{EBO} | – | 50 | nAdc |

ON CHARACTERISTICS (Note 1)

| | | | | |
|--|---------------|----------------|---------------|-----|
| DC Current Gain ($I_C = 1.0\text{ mAdc}$, $V_{CE} = 5.0\text{ Vdc}$) ($I_C = 10\text{ mAdc}$, $V_{CE} = 5.0\text{ Vdc}$) ($I_C = 50\text{ mAdc}$, $V_{CE} = 5.0\text{ Vdc}$) | h_{FE} | 50 60 50 | – 240 – | – |
| Collector–Emitter Saturation Voltage ($I_C = 10\text{ mAdc}$, $I_B = 1.0\text{ mAdc}$) ($I_C = 50\text{ mAdc}$, $I_B = 5.0\text{ mAdc}$) | $V_{CE(sat)}$ | – – | 0.2 0.5 | Vdc |
| Base–Emitter Saturation Voltage ($I_C = 10\text{ mAdc}$, $I_B = 1.0\text{ mAdc}$) ($I_C = 50\text{ mAdc}$, $I_B = 5.0\text{ mAdc}$) | $V_{BE(sat)}$ | – – | 1.0 1.0 | Vdc |

SMALL–SIGNAL CHARACTERISTICS

| | | | | |
|--|-----------|-----|-----|-----|
| Current–Gain — Bandwidth Product ($I_C = 10\text{ mAdc}$, $V_{CE} = 10\text{ Vdc}$, $f = 100\text{ MHz}$) | f_T | 100 | 300 | MHz |
| Output Capacitance ($V_{CB} = 10\text{ Vdc}$, $I_E = 0$, $f = 1.0\text{ MHz}$) | C_{obo} | – | 6.0 | pF |
| Small–Signal Current Gain ($I_C = 1.0\text{ mAdc}$, $V_{CE} = 10\text{ Vdc}$, $f = 1.0\text{ kHz}$) | h_{fe} | 40 | 200 | – |
| Noise Figure ($I_C = 250\ \mu\text{Adc}$, $V_{CE} = 5.0\text{ Vdc}$, $R_S = 1.0\text{ k}\Omega$, $f = 1.0\text{ kHz}$) | NF | – | 8.0 | dB |

1. Pulse Test: Pulse Width $\leq 300\ \mu\text{s}$, Duty Cycle $\leq 2.0\%$.

ORDERING INFORMATION

| Device | Package | Shipping [†] |
|-------------|--------------------|-----------------------|
| 2N5401 | TO–92 | 5000 Unit / Bulk |
| 2N5401RL1 | TO–92 | 2000 Tape & Reel |
| 2N5401RLRA | TO–92 | 2000 Tape & Reel |
| 2N5401RLRAG | TO–92 (Pb–Free) | 2000 Tape & Reel |
| 2N5401RLRM | TO–92 | 2000 Tape & Ammo Box |
| 2N5401ZL1 | TO–92 | 2000 Tape & Ammo Box |

[†]For information on tape and reel specifications, including part orientation and tape sizes, please refer to our Tape and Reel Packaging Specifications Brochure, BRD8011/D.

2N5401

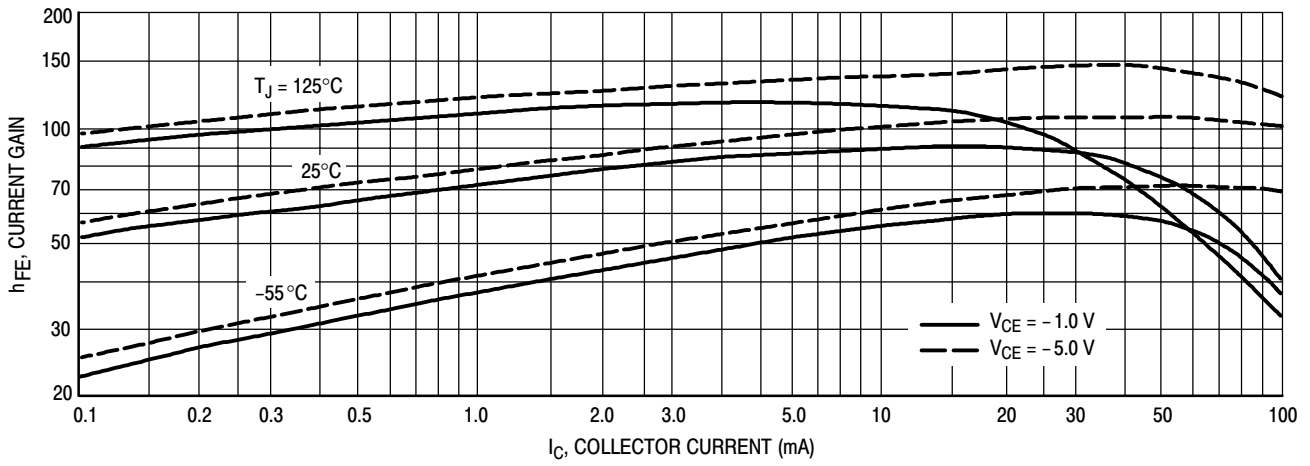

Figure 1. DC Current Gain

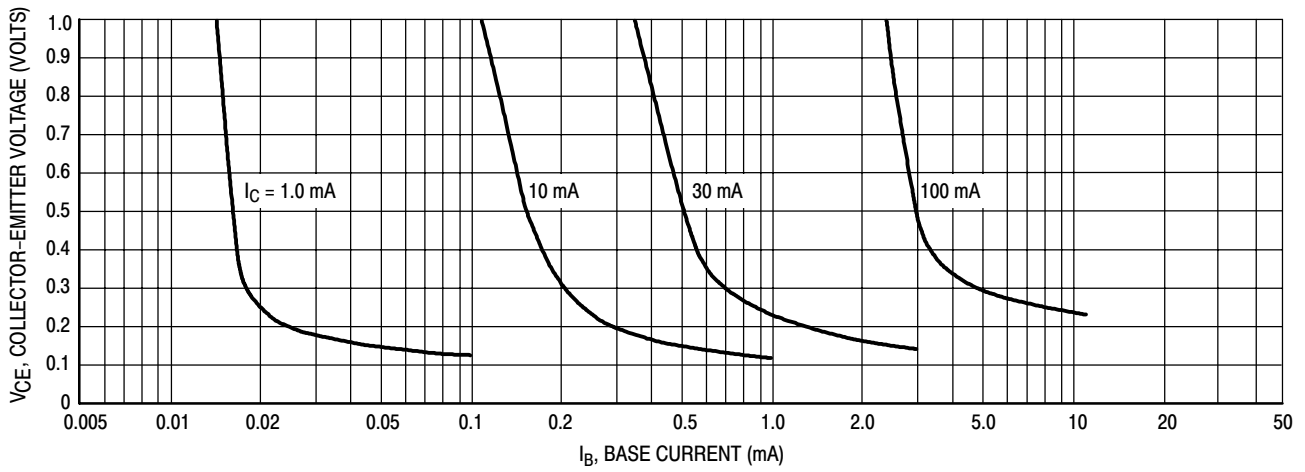

Figure 2. Collector Saturation Region

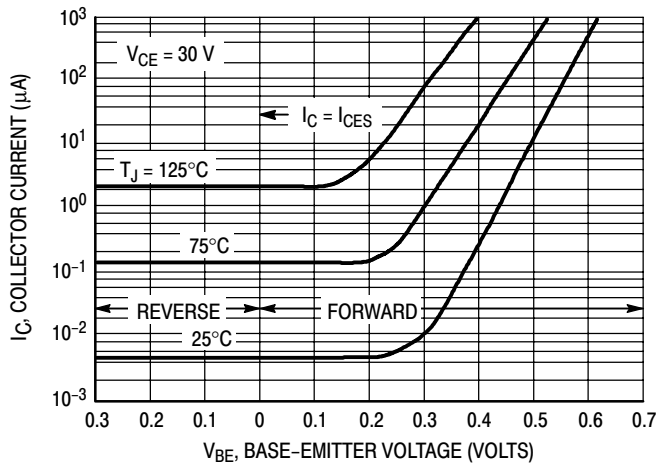

Figure 3. Collector Cut-Off Region

2N5401

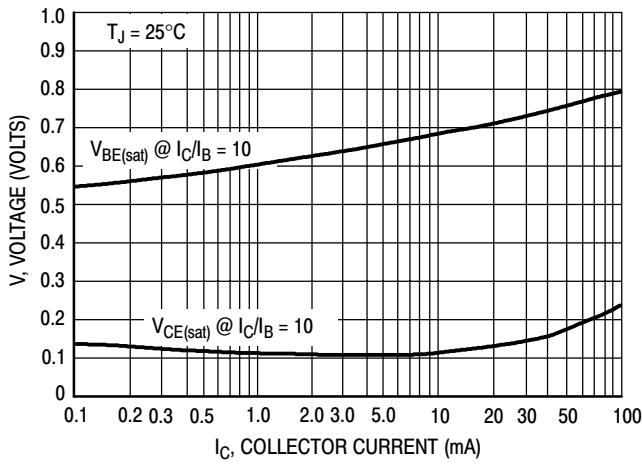

Figure 4. "On" Voltages

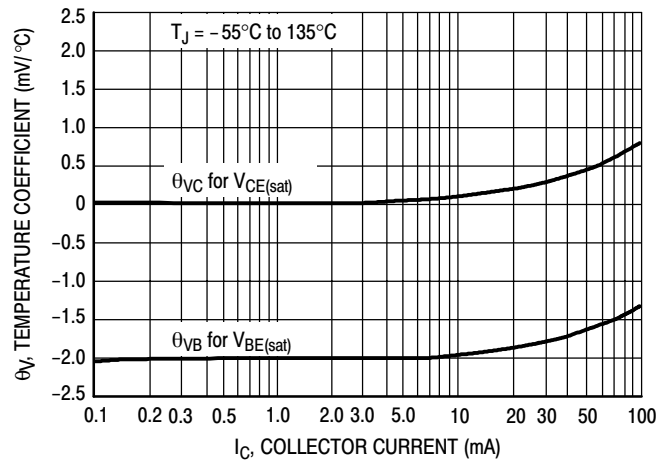

Figure 5. Temperature Coefficients

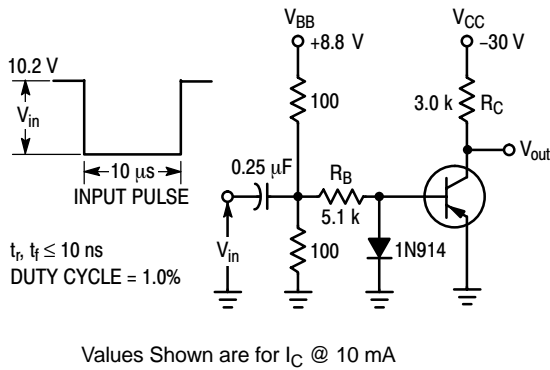

Figure 6. Switching Time Test Circuit

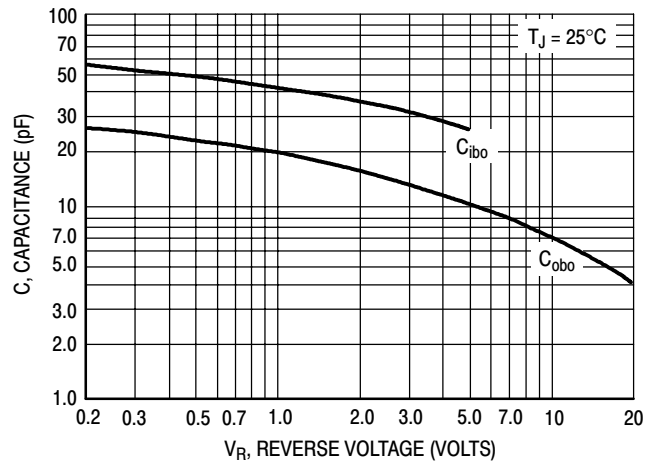

Figure 7. Capacitances

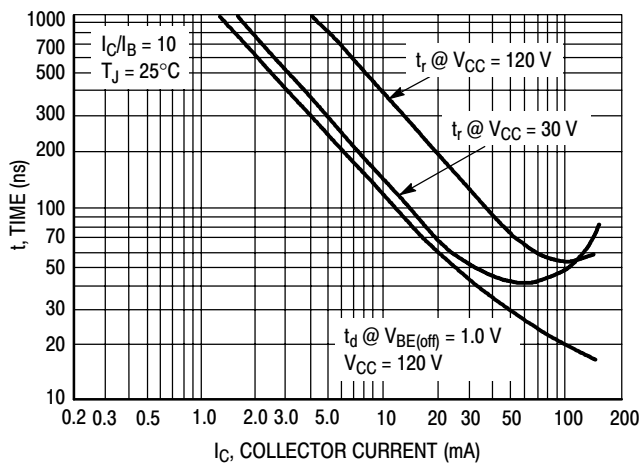

Figure 8. Turn-On Time

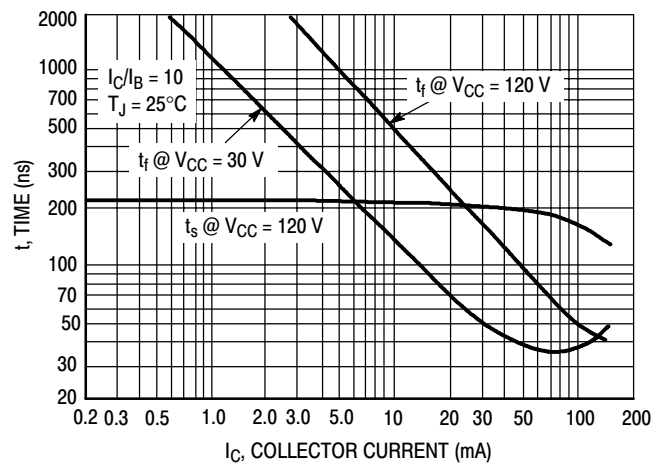
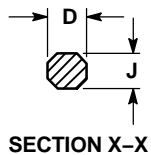
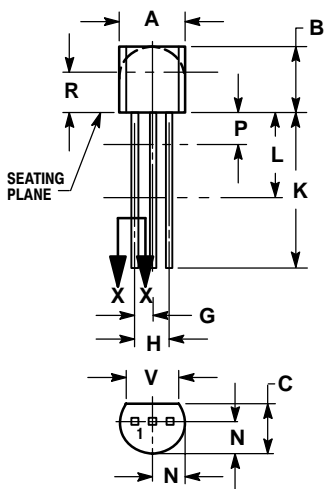

Figure 9. Turn-Off Time

2N5401

PACKAGE DIMENSIONS

TO-92
CASE 29-11
ISSUE AL



NOTES:

1. DIMENSIONING AND TOLERANCING PER ANSI Y14.5M, 1982.
2. CONTROLLING DIMENSION: INCH.
3. CONTOUR OF PACKAGE BEYOND DIMENSION R IS UNCONTROLLED.
4. LEAD DIMENSION IS UNCONTROLLED IN P AND BEYOND DIMENSION K MINIMUM.

| DIM | INCHES | | MILLIMETERS | |
|-----|--------|-------|-------------|-------|
| | MIN | MAX | MIN | MAX |
| A | 0.175 | 0.205 | 4.45 | 5.20 |
| B | 0.170 | 0.210 | 4.32 | 5.33 |
| C | 0.125 | 0.165 | 3.18 | 4.19 |
| D | 0.016 | 0.021 | 0.407 | 0.533 |
| G | 0.045 | 0.055 | 1.15 | 1.39 |
| H | 0.095 | 0.105 | 2.42 | 2.66 |
| J | 0.015 | 0.020 | 0.39 | 0.50 |
| K | 0.500 | --- | 12.70 | --- |
| L | 0.250 | --- | 6.35 | --- |
| N | 0.080 | 0.105 | 2.04 | 2.66 |
| P | --- | 0.100 | --- | 2.54 |
| R | 0.115 | --- | 2.93 | --- |
| V | 0.135 | --- | 3.43 | --- |

STYLE 1:

- PIN 1. EMITTER
2. BASE
3. COLLECTOR

ON Semiconductor and  are registered trademarks of Semiconductor Components Industries, LLC (SCILLC). SCILLC reserves the right to make changes without further notice to any products herein. SCILLC makes no warranty, representation or guarantee regarding the suitability of its products for any particular purpose, nor does SCILLC assume any liability arising out of the application or use of any product or circuit, and specifically disclaims any and all liability, including without limitation special, consequential or incidental damages. "Typical" parameters which may be provided in SCILLC data sheets and/or specifications can and do vary in different applications and actual performance may vary over time. All operating parameters, including "Typicals" must be validated for each customer application by customer's technical experts. SCILLC does not convey any license under its patent rights nor the rights of others. SCILLC products are not designed, intended, or authorized for use as components in systems intended for surgical implant into the body, or other applications intended to support or sustain life, or for any other application in which the failure of the SCILLC product could create a situation where personal injury or death may occur. Should Buyer purchase or use SCILLC products for any such unintended or unauthorized application, Buyer shall indemnify and hold SCILLC and its officers, employees, subsidiaries, affiliates, and distributors harmless against all claims, costs, damages, and expenses, and reasonable attorney fees arising out of, directly or indirectly, any claim of personal injury or death associated with such unintended or unauthorized use, even if such claim alleges that SCILLC was negligent regarding the design or manufacture of the part. SCILLC is an Equal Opportunity/Affirmative Action Employer. This literature is subject to all applicable copyright laws and is not for resale in any manner.

PUBLICATION ORDERING INFORMATION

LITERATURE FULFILLMENT:

Literature Distribution Center for ON Semiconductor
P.O. Box 5163, Denver, Colorado 80217 USA

Phone: 303-675-2175 or 800-344-3860 Toll Free USA/Canada

Fax: 303-675-2176 or 800-344-3867 Toll Free USA/Canada

Email: orderlit@onsemi.com

N. American Technical Support: 800-282-9855 Toll Free
USA/Canada

Japan: ON Semiconductor, Japan Customer Focus Center
2-9-1 Kamimeguro, Meguro-ku, Tokyo, Japan 153-0051
Phone: 81-3-5773-3850

ON Semiconductor Website: <http://onsemi.com>

Order Literature: <http://www.onsemi.com/litorder>

For additional information, please contact your
local Sales Representative.